

NLE11KTK.2 Energy-optimized Tropical Compressor R600a 220-240V 50Hz

General

Code number	105H6173
Approvals	-
Compressors on pallet	80

Application

Application	LBP		
Frequency	Hz	50	60
Evaporating temperature	°C	-35 to -10	-
Voltage range	V	187 - 254	-
Max. condensing temperature continuous (short)	°C	60 (70)	-
Max. winding temperature continuous (short)	°C	125 (135)	-

Cooling requirements

Frequency	Hz	50			60		
Application		LBP	MBP	HBP	LBP	MBP	HBP
32°C		S	-	-	-	-	-
38°C		S	-	-	-	-	-
43°C		S	-	-	-	-	-
Remarks on application:							

Motor

Motor type	RSIR/RSCR		
LRA (rated after 4 sec. UL984), HST LST	A	-	6.5
Cut in Current, HST LST	A	-	11.4
Resistance, main start winding (25°C)	Ω	12.3	10.0

Design

Displacement	cm ³	11.15
Oil quantity (type)	cm ³	300 (mineral)
Maximum refrigerant charge	g	150
Free gas volume in compressor	cm ³	2360
Weight without electrical equipment	kg	10.8

Dimensions

Height	mm	A	203
		B	197
		B1	-
		B2	-
Suction connector	location/I.D. mm angle	C	6.2 15°
	material comment		Cu-plated steel Al cap
Process connector	location/I.D. mm angle	D	6.2 25°
	material comment		Cu-plated steel Al cap
Discharge connector	location/I.D. mm angle	E	5.0 35°
	material comment		Cu-plated steel Al cap
Oil cooler connector	location/I.D. mm angle	F	-
	material comment		-
Connector tolerance	I.D. mm		±0.09, on 5.0 +0.12/+0.20
Remarks:			

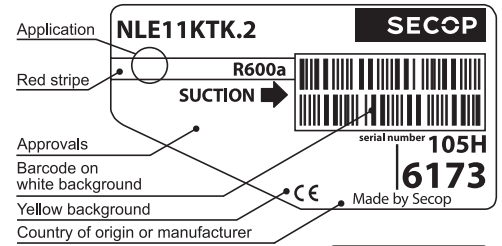

- S = Static cooling normally sufficient
- O = Oil cooling
- F₁ = Fan cooling 1.5 m/s (compressor compartment temperature equal to ambient temperature)
- F₂ = Fan cooling 3.0 m/s necessary
- SG = Suction gas cooling normally sufficient
- = not applicable in this area

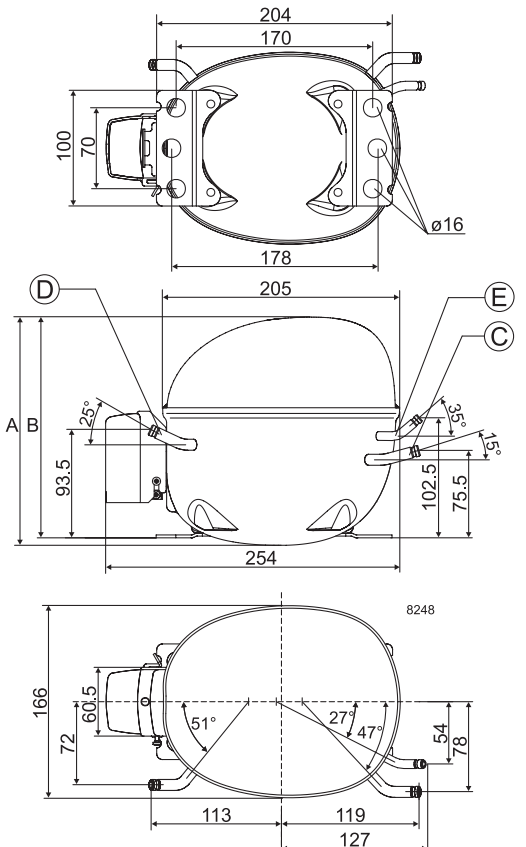

EN 12900 Household (CECOMAF) 220V, 50Hz, 2 W PTC consumption incl., static cooling

Evap. temp. in °C	-45	-40	-35	-30	-25	-23.3	-20	-15	-10	-6.7	-5	0	5	7.2	10	15	20
Capacity in W			84	113	149	163	192	242	302								
Power cons. in W			95	111	126	132	142	158	176								
Current cons. in A			0.85	0.88	0.91	0.92	0.95	1.01	1.07								
COP in W/W			0.88	1.02	1.18	1.24	1.35	1.54	1.72								

ASHRAE LBP 220V, 50Hz, 2 W PTC consumption incl., static cooling

Evap. temp. in °C	-45	-40	-35	-30	-25	-23.3	-20	-15	-10	-6.7	-5	0	5	7.2	10	15	20
Capacity in W			102	139	182	199	234	296	368								
Power cons. in W			96	111	126	131	141	157	175								
Current cons. in A			0.85	0.87	0.91	0.92	0.95	1.01	1.07								
COP in W/W			1.07	1.25	1.44	1.51	1.66	1.88	2.11								

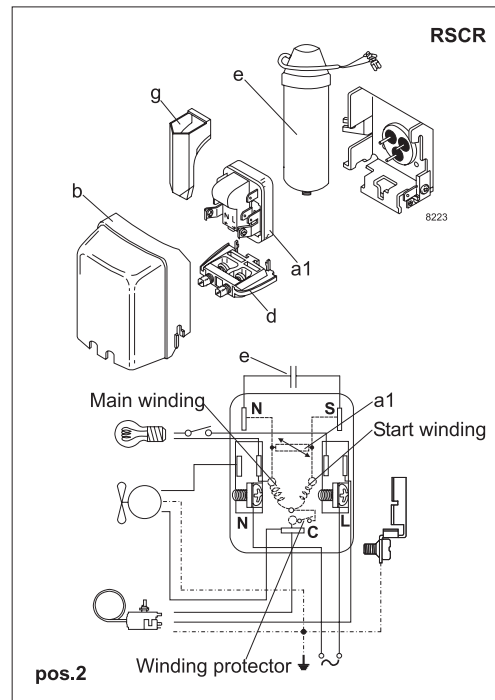
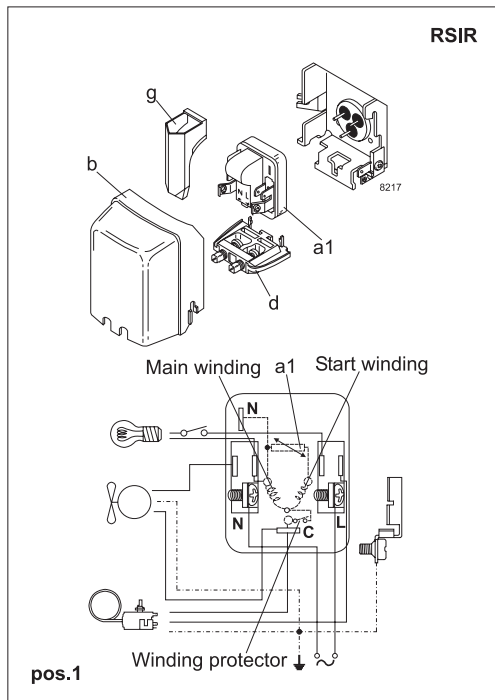

Accessories for	NLE11KTK.2	Figure	Code number
PTC starting device	6.3 mm spade connectors	a1 (pos.1)	103N0011
	4.8 mm spade connectors		103N0018
PTC starting device	6.3 mm spade connectors	a1 (pos.2)	103N0016
	4.8 mm spade connectors		103N0021
ePTC starting device	4.8 mm spade connectors		103N0050
Cover		b	103N2010
Run capacitor 4 µF (optional)	6.3 mm spade connectors	e	117-7117
	4.8 mm spade connectors		117-7119
Cord relief		d	103N1010
Protection screen for PTC		g	103N0476

Test conditions	EN 12900/ CECOMAF	ASHRAE LBP
Condensing temperature	55°C	54.4°C
Ambient temperature	32°C	32°C
Suction gas temperature	32°C	32°C
Liquid temperature	no subcooling	32°C

Mounting accessories	Code number	
Bolt joint for one comp.	Ø: 16 mm	118-1917
Bolt joint in quantities	Ø: 16 mm	118-1918
Snap-on in quantities	Ø: 16 mm	118-1919

Nidec GA Compressors accepts no responsibility for possible errors in catalogs, brochures, and other printed material. Nidec GA Compressors reserves the right to alter its products without notice. This also applies to products already on order provided that such alterations can be made without subsequential changes being necessary to specifications already agreed. All trademarks in this material are the property of the respective companies. Secop and the Secop logotype are trademarks of Nidec Global Appliance Germany GmbH. All rights reserved. www.secop.com