

Data sheets

For HFC/HFO/HCFC refrigerants > Standard single-phase series

Technical data:		
Cylinders	#	2
Displacement @ 50 Hz	m ³ /h [50Hz]	13.15
Displacement @ 60 Hz	m ³ /h [60Hz]	15.78
Motor version[1]		2
Nominal Motor power (HP)		2
Nominal Motor power (kW)		1.5
Motor voltage at 50 Hz[2]	V/ph/Hz	220-240V/1/50Hz DOL
Motor voltage at 60 Hz[2]	V/ph/Hz	265-290V/1/60Hz DOL
Bridges for DOL start		Standard
MRA, maximum operating current at 230V/50Hz and	A	19.6
LRA, maximum starting current at 230V/50Hz and	A	79.2
Frequency min	Hz	NO
Frequency max[3]	Hz	NO
Control and protection device		INT69®
Electric terminal box class protection		IP56
Maximum pressure HP	bar	30
Maximum pressure LP	bar	20.5
Oil type[4]		POE32
Oil charge (3/4 of sight glass)	l	1.1
Lubrication type		Centrifugal
Suction valve (SV)	inch	7/8
Discharge valve (DV)	inch	5/8
Net weight	kg	45
Max Length	mm	374
Max Width	mm	242
Max Height	mm	294
Rubber mounts diameter[2]	mm	30
Rubber mounts height	mm	30
Rubber mounts shore	sh	45
Sound power level (-10/45, R404A)[5]	dB(A)	66.5
Sound pressure level @ 1m (-10/45, R404A)[5]	dB(A)	58.5
Compressor body material		Cast Iron

- [1] Motor version: 1 = high and mid temperature, all refrigerants; 2 = low and mid temperature, all refrigerants; 3 = ECOinside, low temperature, R134a and R1234ze only
- [2] Others available on request
- [3] Maximum frequency depends on the working condition: see FSS3 (Frascold selection software)
- [4] Different kind of oil available on request

Data sheets

For HFC/HFO/HCFC refrigerants > Standard single-phase series

Accessories:	
Oil heater (230V-50W)	T00CH13-RIC
Optoelectronic oil level switch	T00WK252
Electronic oil level regulator	T00EC1900
Head cooling fan - 230V/1/50-60Hz	SZ-FM1
Terminal plate cover	T00EC09C
Kit adapters for oil equalization line - 1" ROT 5/8" ODS	T00SK170200
Kit adapters for oil equalization line - 1"1/4 ROT 1"1/8 ODS	T00SK170300

Data sheets

For HFC/HFO/HCFC refrigerants > Standard single-phase series

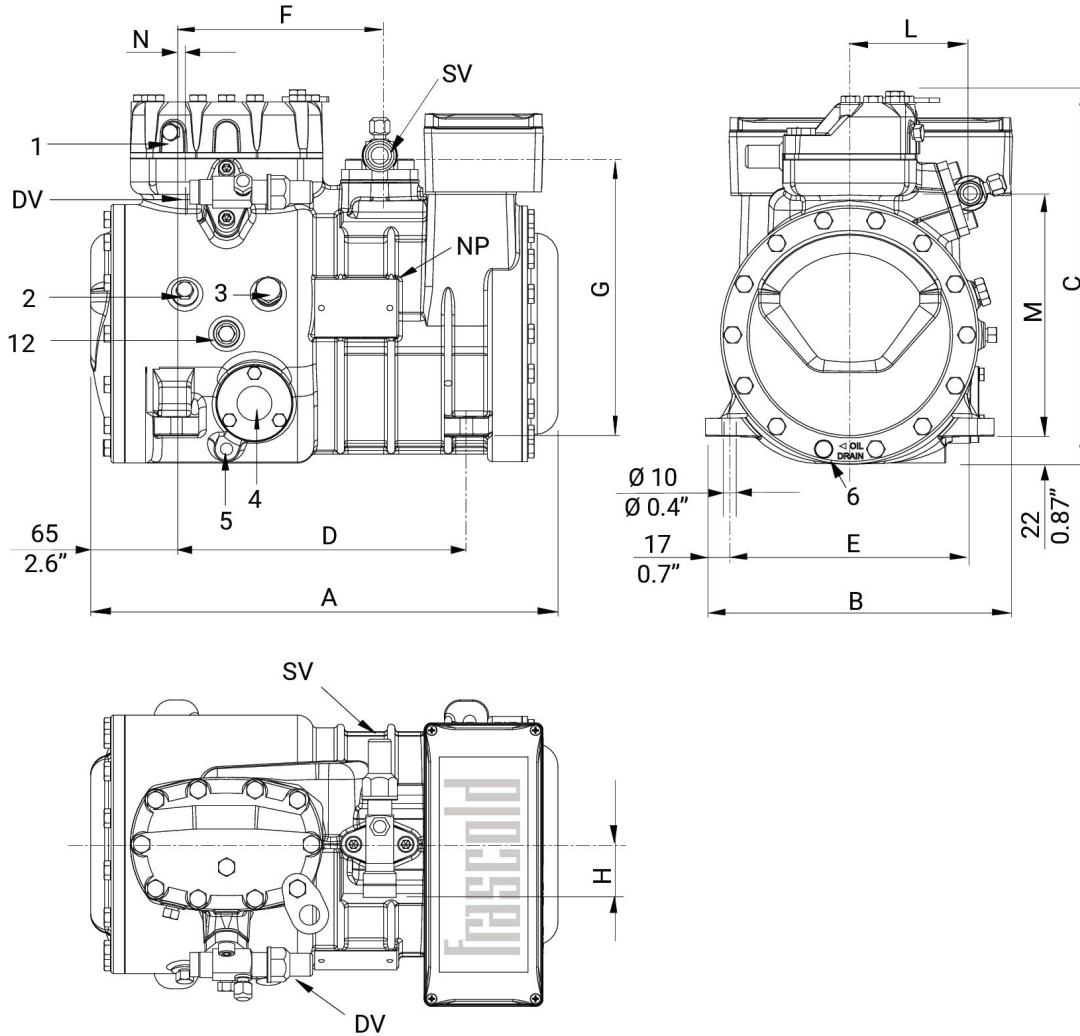

Dimensional drawing:

SV Suction valve	mm	22.2
DV Discharge valve	mm	15.8
SV Suction valve	inch	7/8
DV Discharge valve	inch	5/8
A Length	mm	374
B Width	mm	242
C Height	mm	294
D Base mounting	mm	234
E Base mounting	mm	194
F Suction valve	mm	165
G Suction valve	mm	221
H Suction valve	mm	42
L Discharge valve	mm	94
M Discharge valve	mm	192
N Discharge valve	mm	13
1 High pressure plug		1/8" NPT

2 Low pressure plug	1/8" NPT
3 Oil charge plug	1/4" GAS
4 Oil level sight glass	-
5 Crankcase heater	-
6 Oil drain plug	M8 x 22
12 Oil return plug	1/8" NPT
DV Discharge valve	-
SV Suction valve	-
NP Name Plate	-