

D (1/8" NPT) C (1/8" NPT) SL Q (3/4" NPT) DL M H (1/8" NPT)

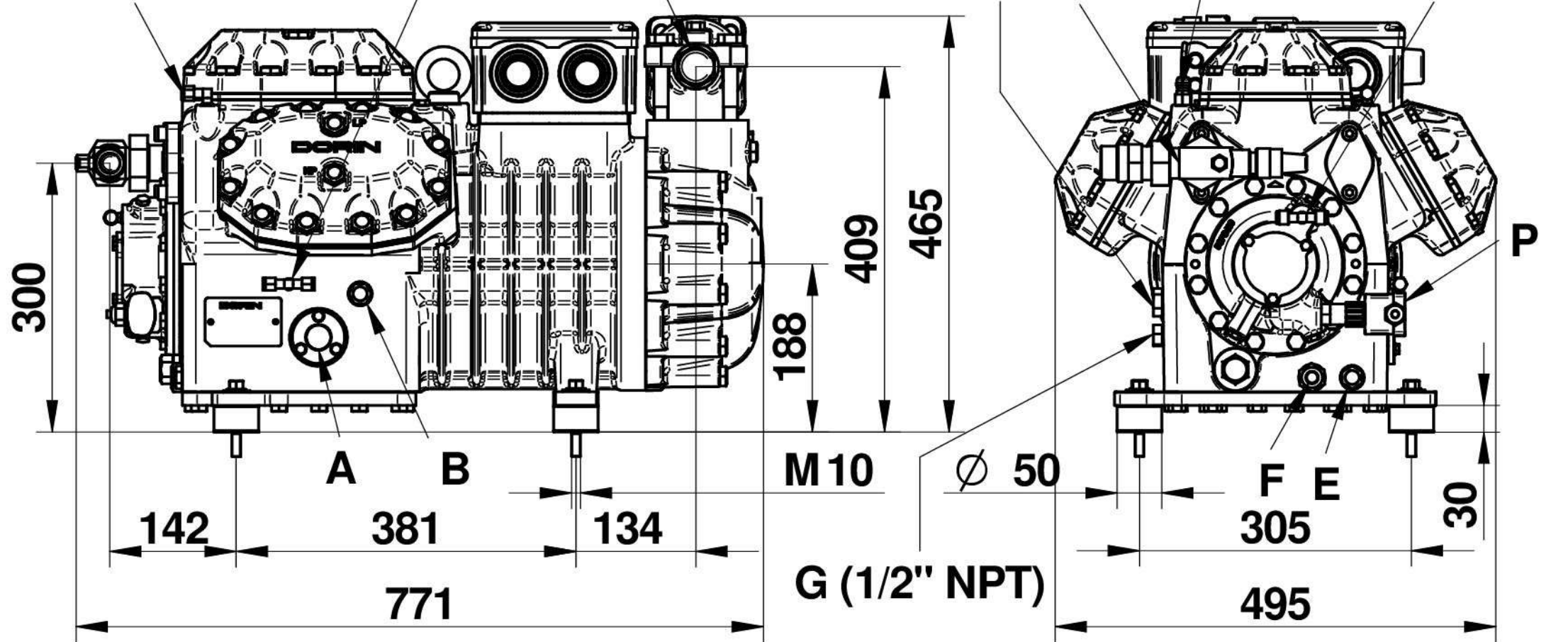

H61 27-5-15