

D (1/8" NPT) C (1/8" NPT) SL Q (3/4" NPT)

DL M H (1/8" NPT)

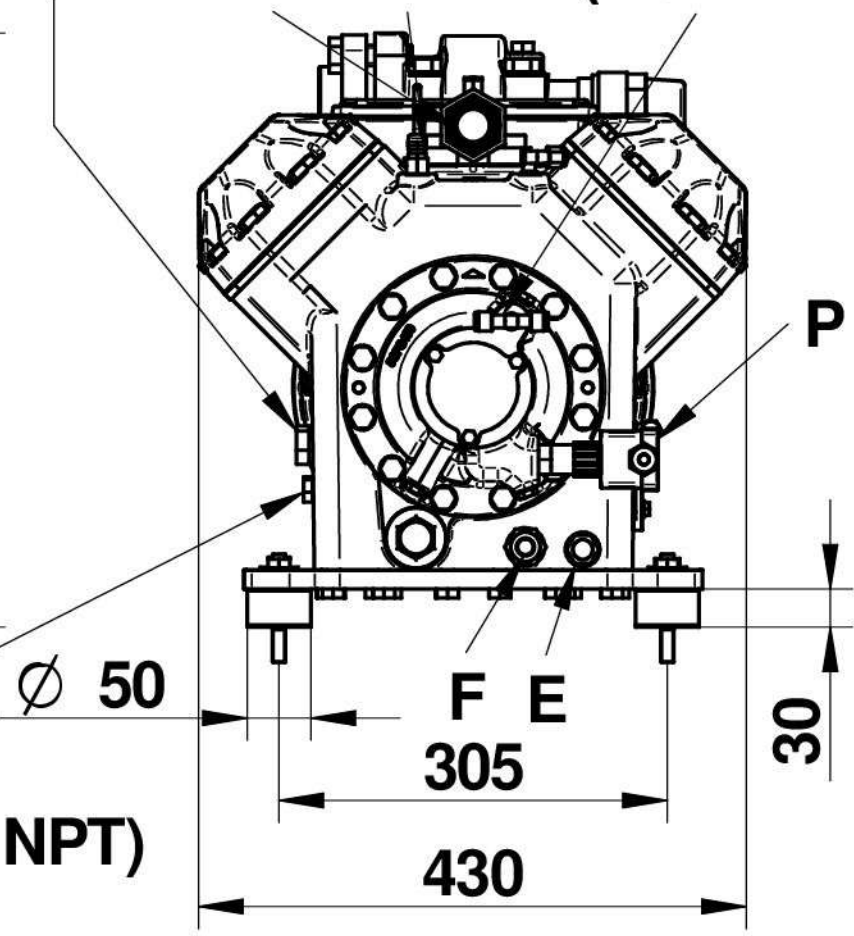
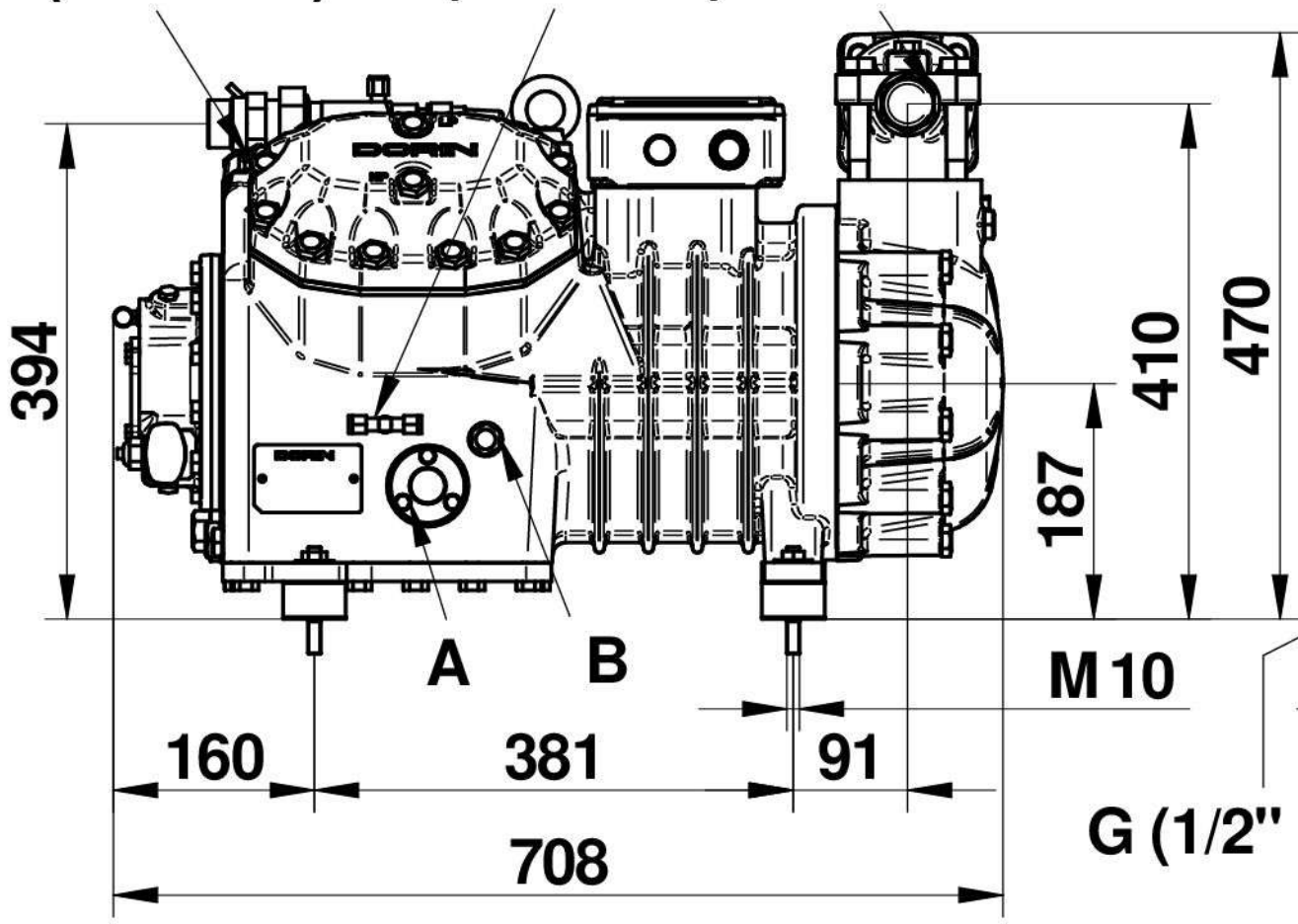

H53 27-5-15