

## NL7.3MF Standard Compressor R134a 220-240V 50Hz & 208-230V 60Hz

### General

Code number	105G6772
Approvals	EN 60335-2-34, UL984
Compressors on pallet	80

### Application

Application	MBP			
	Hz	50	60	
Frequency	Hz	50	60	
Evaporating temperature	°C	-20 to 15	-35 to 7.2	
Voltage range	V	187 - 254	198 - 254	
Max. condensing temperature continuous (short)	°C	60 (70)	60 (70)	
Max. winding temperature continuous (short)	°C	125 (135)	125 (135)	

### Cooling requirements

Frequency	Hz	50			60		
		LBP	MBP	HBP	LBP	MBP	HBP
32°C		-	F <sub>1</sub>	F <sub>1</sub>	F <sub>1</sub>	F <sub>1</sub>	-
38°C		-	F <sub>1</sub>	F <sub>1</sub>	F <sub>1</sub>	F <sub>1</sub>	-
43°C		-	F <sub>1</sub>	F <sub>1</sub>	F <sub>1</sub>	F <sub>1</sub>	-

Remarks on application: F<sub>2</sub> for 230-240V 50Hz nominal below -12°C evaporating temp. CSIR strongly recommended for 60Hz

### Motor

Motor type	RSIR/CSIR	
LRA (rated after 4 sec. UL984), HST   LST	A	11.3   8.8
Cut in Current, HST   LST	A	11.3   12.9
Resistance, main   start winding (25°C)	Ω	8.3   17.0

### Design

Displacement	cm <sup>3</sup>	7.27
Oil quantity (type)	cm <sup>3</sup>	270 (polyolester)
Maximum refrigerant charge	g	600
Free gas volume in compressor	cm <sup>3</sup>	2360
Weight without electrical equipment	kg	10.5

### Dimensions

Height	mm	A	197
		B	191
		B1	-
		B2	-
Suction connector	location/I.D. mm   angle	C	8.2   15°
	material   comment		Copper   Rubber plug
Process connector	location/I.D. mm   angle	D	6.2   25°
	material   comment		Copper   Rubber plug
Discharge connector	location/I.D. mm   angle	E	6.2   35°
	material   comment		Copper   Rubber plug
Oil cooler connector	location/I.D. mm   angle	F	-
	material   comment		-
Connector tolerance	I.D. mm		±0.09
Remarks:			

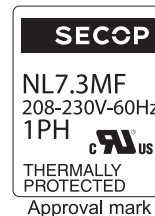
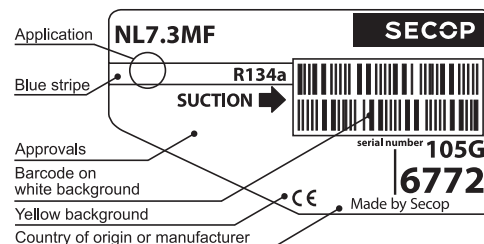

- S = Static cooling normally sufficient
- O = Oil cooling
- F<sub>1</sub> = Fan cooling 1.5 m/s (compressor compartment temperature equal to ambient temperature)
- F<sub>2</sub> = Fan cooling 3.0 m/s necessary
- SG = Suction gas cooling normally sufficient
- = not applicable in this area

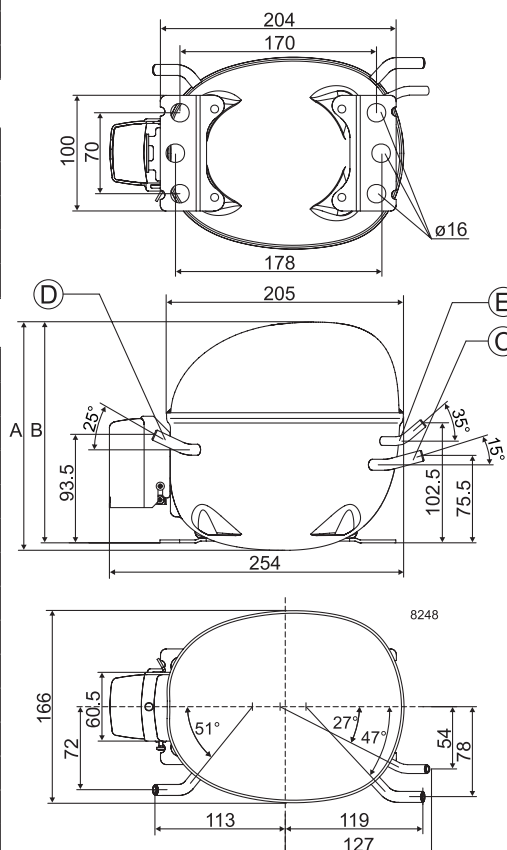

**EN 12900 Household (CECOMAF)** 220V, 50Hz, fan cooling F<sub>1</sub>

Evap. temp. in °C	-45	-40	-35	-30	-25	-23.3	-20	-15	-10	-6.7	-5	0	5	7.2	10	15	20
Capacity in W							179	236	304	356	385	480	591	645	719	867	
Power cons. in W							181	204	227	242	250	274	298	310	325	352	
Current cons. in A							1.57	1.61	1.67	1.71	1.74	1.82	1.91	1.96	2.02	2.14	
COP in W/W							0.99	1.16	1.34	1.47	1.54	1.75	1.98	2.08	2.21	2.46	

**EN 12900 Household (CECOMAF)** 220V, 60Hz, fan cooling F<sub>1</sub>

Evap. temp. in °C	-45	-40	-35	-30	-25	-23.3	-20	-15	-10	-6.7	-5	0	5	7.2	10	15	20
Capacity in W			73	113	159	177	216	283	363	424	458	570	700	763			
Power cons. in W			110	141	174	185	207	241	275	298	310	344	379	394			
Current cons. in A			1.11	1.20	1.30	1.34	1.41	1.53	1.66	1.75	1.80	1.94	2.09	2.16			
COP in W/W			0.67	0.80	0.92	0.96	1.04	1.17	1.32	1.42	1.48	1.65	1.85	1.93			

**ASHRAE MBP** 220V, 50Hz, fan cooling F<sub>1</sub>

Evap. temp. in °C	-45	-40	-35	-30	-25	-23.3	-20	-15	-10	-6.7	-5	0	5	7.2	10	15	20
Capacity in W							198	261	336	393	425	530	652	712	794	958	
Power cons. in W							181	204	226	241	249	273	297	308	323	351	
Current cons. in A							1.57	1.61	1.67	1.71	1.74	1.82	1.91	1.95	2.02	2.14	
COP in W/W							1.09	1.28	1.49	1.63	1.71	1.94	2.19	2.31	2.46	2.73	

**ASHRAE MBP** 220V, 60Hz, fan cooling F<sub>1</sub>

Evap. temp. in °C	-45	-40	-35	-30	-25	-23.3	-20	-15	-10	-6.7	-5	0	5	7.2	10	15	20
Capacity in W			82	125	177	197	239	313	402	469	506	630	773	844			
Power cons. in W			111	142	174	185	207	240	274	297	308	343	377	392			
Current cons. in A			1.11	1.20	1.30	1.34	1.41	1.53	1.66	1.74	1.79	1.93	2.09	2.15			
COP in W/W			0.74	0.88	1.02	1.06	1.15	1.30	1.47	1.58	1.64	1.84	2.05	2.15			

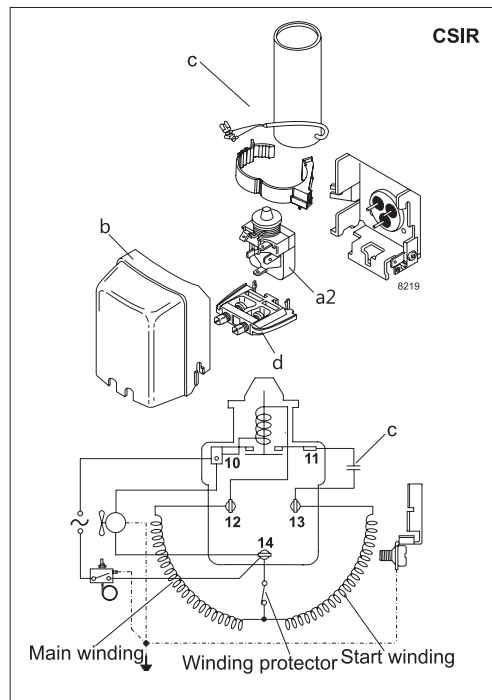
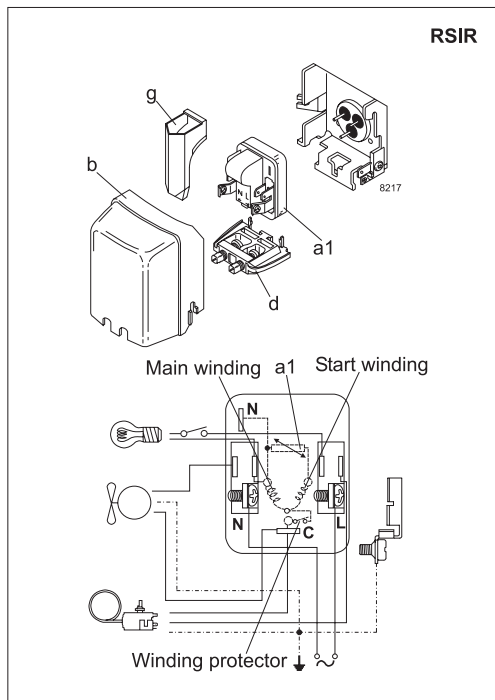

Accessories for	NL7.3MF	Figure	Code number
PTC starting device	6.3 mm spade connectors	a1	103N0011
	4.8 mm spade connectors		103N0018
Starting relay	6.3 mm spade connectors	a2	117U6016
Start. capacitor 80 µF	6.3 mm spade connectors	c	117U5015
Cover		b	103N2011
Cord relief		d	103N1010
Protection screen for PTC		g	103N0476

Test conditions	EN 12900/CECOMAF	ASHRAE
Condensing temperature	55°C	54.4°C
Ambient temperature	32°C	35°C
Suction gas temperature	32°C	35°C
Liquid temperature	no subcooling	46.1°C

Mounting accessories		Code number
Bolt joint for one comp.	Ø: 16 mm	118-1917
Bolt joint in quantities	Ø: 16 mm	118-1918
Snap-on in quantities	Ø: 16 mm	118-1919

Nidec GA Compressors accepts no responsibility for possible errors in catalogs, brochures, and other printed material. Nidec GA Compressors reserves the right to alter its products without notice. This also applies to products already on order provided that such alterations can be made without subsequential changes being necessary to specifications already agreed. All trademarks in this material are the property of the respective companies. Secop and the Secop logotype are trademarks of Nidec Global Appliance Germany GmbH. All rights reserved. [www.secop.com](http://www.secop.com)