

226

H

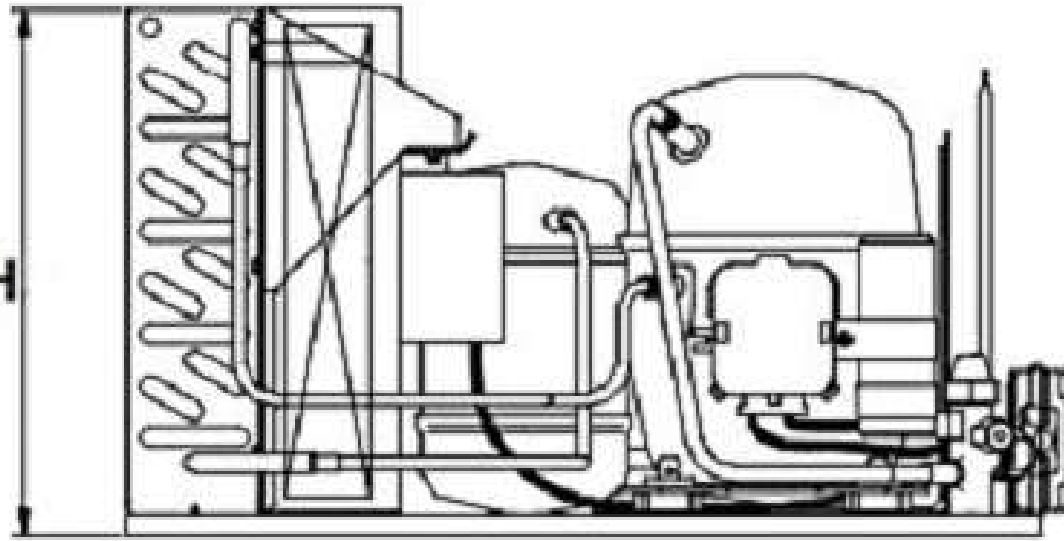

304

W

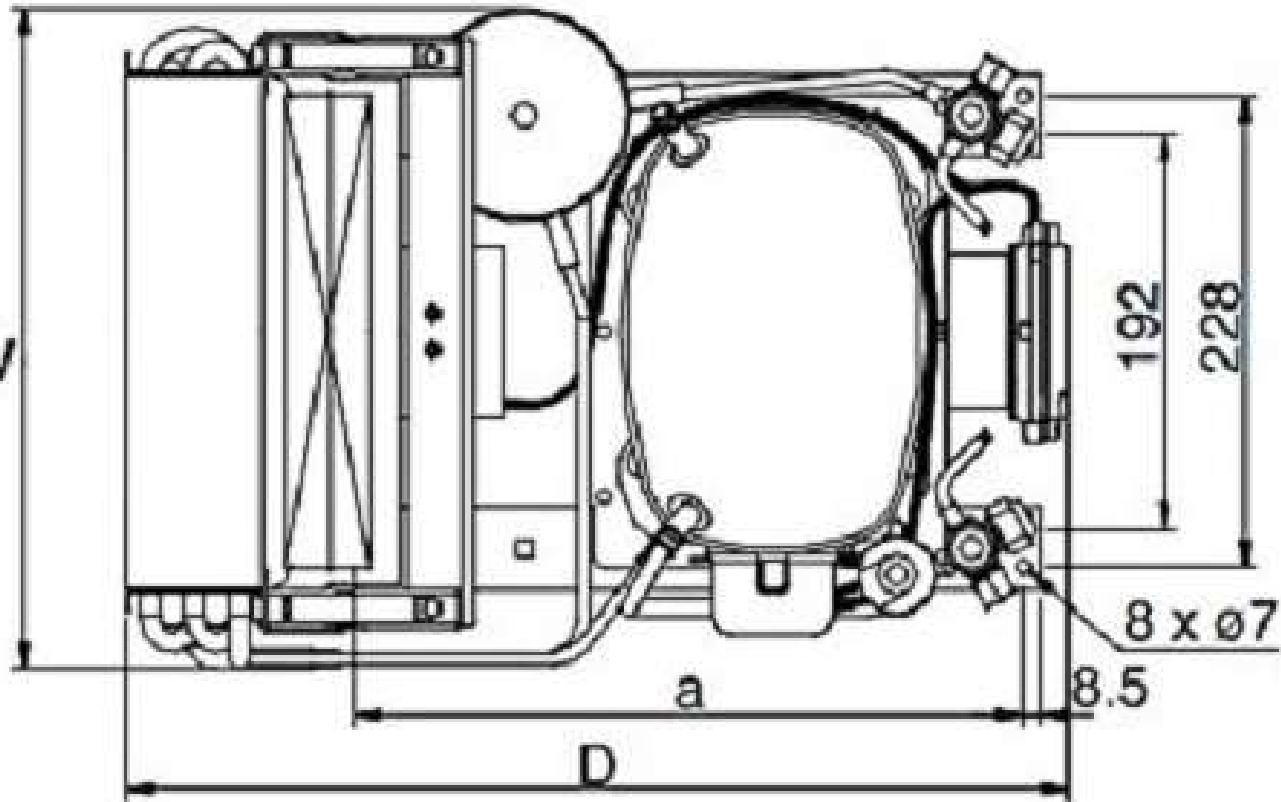

432