

SC10DL MBP/HBP Compressor R404A/R507 & R407C 220-240V 50Hz

General

Code number	104L2525
Approvals	EN 60335-2-34
Compressors on pallet	80

Application

Application	MBP/HBP		
Frequency	Hz	50	60
Evaporating temperature	°C	-20 to 15	-
Voltage range	V	198 - 254	-
Max. condensing temperature continuous (short)	°C	55 (60)	-
Max. winding temperature continuous (short)	°C	125 (135)	-

Cooling requirements

Frequency	Hz	50			60		
Application		LBP	MBP	HBP	LBP	MBP	HBP
32°C		-	F ₂	F ₂	-	-	-
38°C		-	F ₂	F ₂	-	-	-
43°C		-	-	-	-	-	-
Remarks on application:							

Motor

Motor type	CSIR		
LRA (rated after 4 sec. UL984), HST LST	A	14.8	-
Cut in Current, HST LST	A	14.8	-
Resistance, main start winding (25°C)	Ω	5.0	13.7

Design

Displacement	cm ³	10.29
Oil quantity (type)	cm ³	600 (polyolester)
Maximum refrigerant charge	g	1300
Free gas volume in compressor	cm ³	1410
Weight without electrical equipment	kg	13.1

Dimensions

Height	mm	A	209
		B	203
		B1	183
		B2	100
Suction connector	location/I.D. mm angle	C	8.2 37°
	material comment		Copper Rubber plug
Process connector	location/I.D. mm angle	D	6.2 37°
	material comment		Copper Rubber plug
Discharge connector	location/I.D. mm angle	E	6.2 37°
	material comment		Copper Rubber plug
Oil cooler connector	location/I.D. mm angle	F	-
	material comment		-
Connector tolerance	I.D. mm		±0.09
Remarks:			

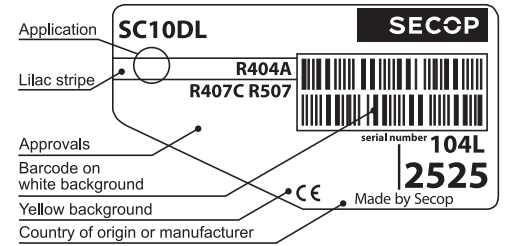

- S = Static cooling normally sufficient
- O = Oil cooling
- F₁ = Fan cooling 1.5 m/s
(compressor compartment temperature equal to ambient temperature)
- F₂ = Fan cooling 3.0 m/s necessary
- SG = Suction gas cooling normally sufficient
- = not applicable in this area

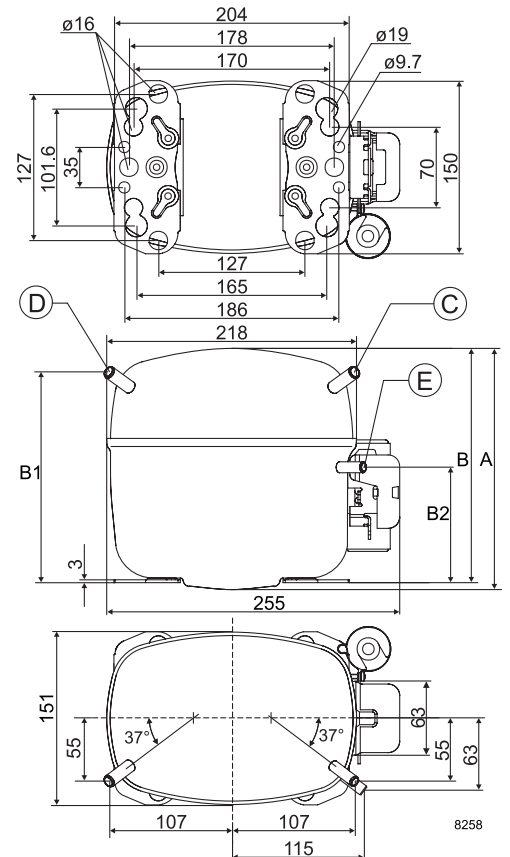

EN 12900 Household (CECOMAF) R404A/R507, 220V, 50Hz, fan cooling F₂

Evap. temp. in °C	-45	-40	-35	-30	-25	-23.3	-20	-15	-10	-6.7	-5	0	5	7.2	10	15	20
Capacity in W							471	611	775	899	968	1192	1450	1576	1747	2085	
Power cons. in W							373	429	479	508	522	559	590	601	614	631	
Current cons. in A							2.55	2.78	2.97	3.09	3.15	3.30	3.42	3.47	3.53	3.61	
COP in W/W							1.26	1.42	1.62	1.77	1.85	2.13	2.46	2.62	2.85	3.30	

ASHRAE LBP R404A/R507, 220V, 50Hz, fan cooling F₂

Evap. temp. in °C	-45	-40	-35	-30	-25	-23.3	-20	-15	-10	-6.7	-5	0	5	7.2	10	15	20
Capacity in W							547	710	902	1047	1128	1391	1696	1845	2048	2451	
Power cons. in W							373	429	479	508	522	559	590	601	614	631	
Current cons. in A							2.55	2.78	2.97	3.09	3.15	3.30	3.42	3.47	3.53	3.61	
COP in W/W							1.47	1.66	1.89	2.06	2.16	2.49	2.88	3.07	3.34	3.88	

EN 12900 Household (CECOMAF) R407C, 220V, 50Hz, fan cooling F₂

Evap. temp. in °C	-45	-40	-35	-30	-25	-23.3	-20	-15	-10	-6.7	-5	0	5	7.2	10	15	20
Capacity in W								480	636	752	821	1039	1293	1417	1588	1927	
Power cons. in W								346	394	421	437	476	510	524	540	568	
Current cons. in A								2.50	2.66	2.75	2.81	2.95	3.08	3.14	3.20	3.31	
COP in W/W								1.39	1.61	1.78	1.88	2.18	2.54	2.71	2.94	3.40	

ASHRAE LBP R407C, 220V, 50Hz, fan cooling F₂

Evap. temp. in °C	-45	-40	-35	-30	-25	-23.3	-20	-15	-10	-6.7	-5	0	5	7.2	10	15	20
Capacity in W								515	682	806	881	1114	1388	1522	1706	2073	
Power cons. in W								346	394	421	437	476	510	524	540	568	
Current cons. in A								2.50	2.66	2.75	2.81	2.95	3.08	3.14	3.20	3.31	
COP in W/W								1.49	1.73	1.91	2.01	2.34	2.72	2.91	3.16	3.65	

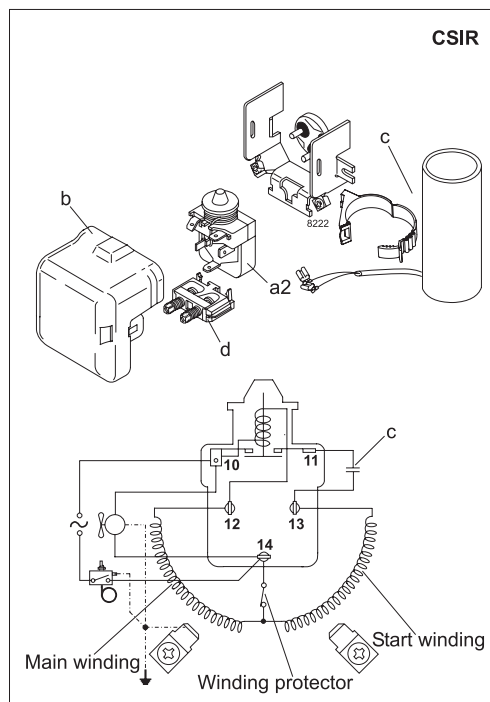

Accessories for	SC10DL	Figure	Code number	Test conditions	EN 12900/CECOMAF	ASHRAE LBP
PTC starting device	6.3 mm spade connectors	a1	–	Condensing temperature	45°C	45°C
	4.8 mm spade connectors		–	Ambient temperature	32°C	32°C
Starting relay	6.3 mm spade connectors	a2	117U6005	Suction gas temperature	32°C	32°C
Cover		b	103N2009	Liquid temperature	45°C	32°C
Start. capacitor 80 µF	6.3 mm spade connectors	c	117U5017			
Cord relief		d	103N1004			
Protection screen for PTC		g	–			

Mounting accessories		Code number
Bolt joint for one comp.	Ø: 16 mm	118-1917
Bolt joint in quantities	Ø: 16 mm	118-1918
Snap-on in quantities	Ø: 16 mm	118-1919

Nidec GA Compressors accepts no responsibility for possible errors in catalogs, brochures, and other printed material. Nidec GA Compressors reserves the right to alter its products without notice. This also applies to products already on order provided that such alterations can be made without consequential changes being necessary to specifications already agreed. All trademarks in this material are the property of the respective companies. Secop and the Secop logotype are trademarks of Nidec Global Appliance Germany GmbH. All rights reserved. www.secop.com