

275

425

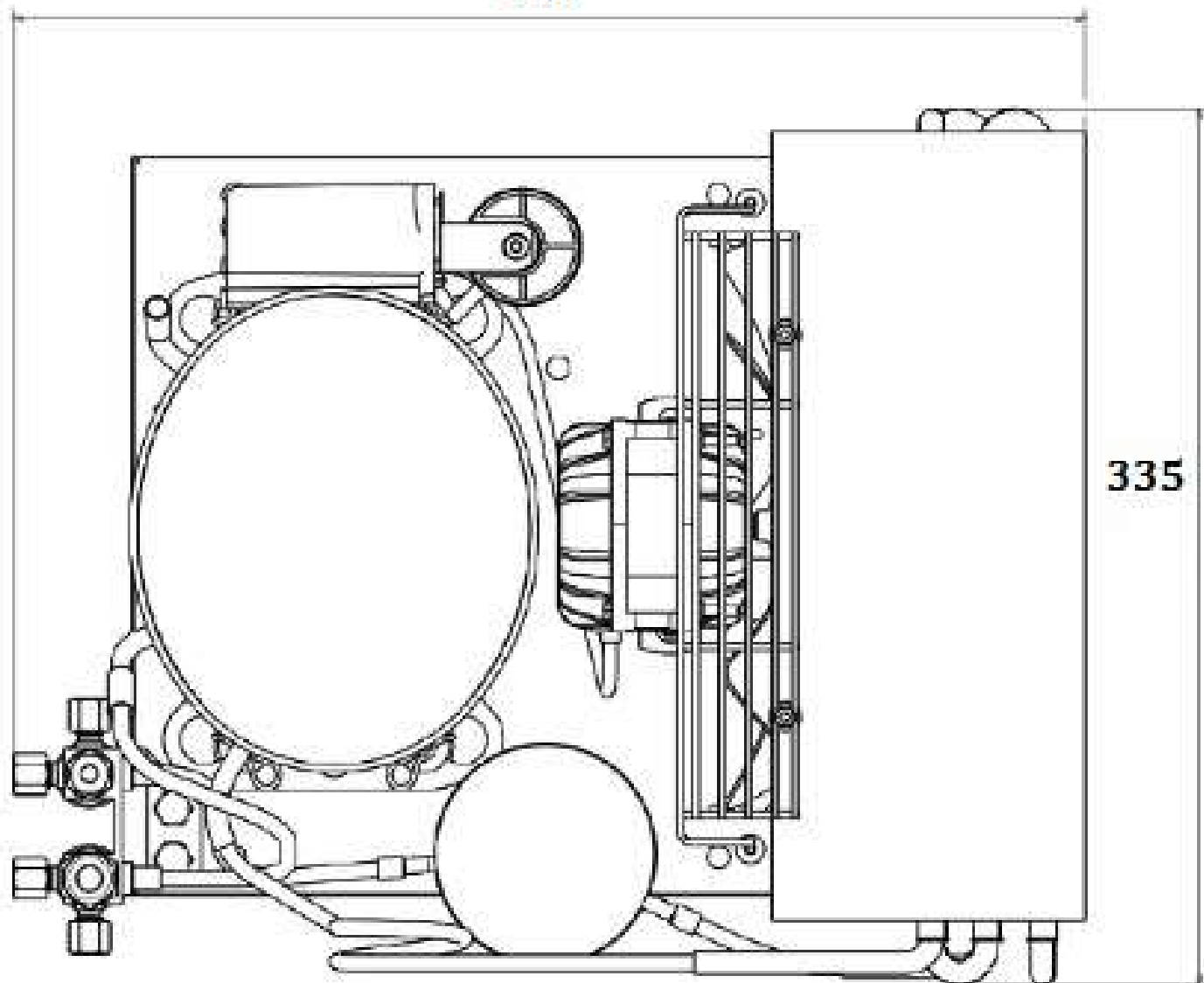

335