

VALUE[®]

Recovery Unit Manual

VRR24M



www.worldvalue.cn

TABLE OF CONTENT

| | |
|--------------------------------------|----|
| General Safety..... | 1 |
| Operation Manual..... | 3 |
| Specification..... | 5 |
| Introduction of Operation Panel..... | 6 |
| Parts Diagram..... | 7 |
| Wiring Diagram..... | 8 |
| Operating Instruction | |
| 1). Refrigerant pipes' exhaust..... | 9 |
| 2). Recovery Method..... | 10 |
| 3). Self-purge Method..... | 11 |
| 4). Liquid Push/Pull Method..... | 12 |
| Trouble Shooting..... | 13 |

GENERAL SAFETY

Use information

- In order to prolong the usage of the recovery unit, please read the operating manual carefully before using, which can help you to fully understand the safety, specification as well as operating procedure of the recovery unit.
- Please check the product received is same as you ordered and also the I are attached.
Please check the product if there is any damage during transportation.
Contact with local distributor if the above problem is found.
- Please read the operating manual carefully and use the unit according to the product operating procedures.

Safety indication

Warning

This mark indicates procedures that must be strictly observed to prevent hazards to people.

Notice

This mark indicates procedures must be strictly observed to prevent damage or destruction of the unit.

Matters needing attention

Warning

Only a qualified technician can operate this recovery unit.

Before starting the equipment, make sure that it is well grounded.

While using electrical wire, the wire must be well connected and grounded.

Only a qualified electrician can do the wire connection according to the technical standard and circuit diagram.

The power must be cut off and no display in LCD before inspecting or repairing.

If the original power supply cord is damaged, choose carefully for the replacing one, or you may directly buy from VALUE distributor.

Please take power supply and the capacity of your ammeter and electrical wire.

GENERAL SAFETY

Only authorized refillable refrigerant tanks can be used. It requires the use of recovery tanks with a minimum working pressure of 45 bar(652.6 psi). Do not overfill the recovery tank, maximum at 80% capacity to make sure that there is enough space for liquid expansion. Overfilling of the tank may cause a violent explosion.

Always wear safety goggles and protective gloves while working with refrigerants to protect your skin and eye from hurting by refrigerant gases or liquid.

Do not use this equipment near flammable liquid or gasoline.

An electric scale is needed to prevent overfilling.

Be sure that the place where you are working is thoroughly ventilated.

Notice

Be sure the unit is working under the right power supply.

When using an extension cord it should be minimum 2.0mm² AWG and no longer than 7.5 m, otherwise it may cause the voltage drop and damage the compressor.

The input pressure of the unit should not exceed 26bar (377.0psi) .

The unit need to be laid in horizontally, otherwise it will lead to unexpected vibration, noise or even abrasion.

Do not expose the equipment to sun or rain.

The ventilation opening of the unit must not be blocked.

If the overload protector pops, reposition it after 5 minutes.

When doing self purging operation, the knob must be turned slowly to "PURGE" to ensure the inlet pressure is less than 5 bar.

If fluid hammer happens in the recovery, please turn the knob slowly to "LIQUID" position and do not let reading pressure drop to zero.

OPERATION MANUAL

1. Do not mix different refrigerants together in one tank, otherwise they could not be separated or used.
2. Before recovering the refrigerant, the tank should achieve the vacuum level: -75cmHg(-29.6inHg), in order to for purge non-condensable gases. Each tank was full of nitrogen when it was manufactured in the factory, thus the nitrogen should be evacuated before first use.
3. The knob should be at "Close" Position before operation. All the valves must be closed, the input and output fittings should be covered with protective caps when the unit is not in operation. The air moisture is harmful to the recovery result and will shorten the life span of the unit.
4. A filter drier should always be used and should be replaced regularly. And each type of refrigerant must have its own filter. For the sake of ensuring the normal operation of the unit, please use the filter specified by our company. High quality filter drier will bring high quality services.
5. Special-caution is needed when recovering from sinter system, and two dry filters are needed.
6. The unit has an Internal High Pressure protector. If the pressure inside the system is above rated shut-off pressure (see specification), compressor will automatically shut off and the HP light is on.
To restart the compressor, please lower the internal pressure (Output gauge indicates lower than 30 bar/435.0 PSI), after the HP light blinks, then Press the "⊖" button to restart the compressor.
When high pressure protection is initiated, please find out the cause and deal with it before restarting the unit.
Cause of High Pressure Protection and Trouble Shooting:
 - ① The input valve of the refrigerant tank is closed——open the valve will help solve the problem.
 - ② The connecting hose between the recovery unit and refrigerant tank is stuck——close all the valves and replace the connecting hose.
 - ③ The temperature of the refrigerant tank is too high, pressure is too high causing high pressure——make the tank cool.
7. The unit has an Internal Low Pressure protector, If the pressure inside the system lower than -15inHg LP light is on after 20 seconds, and recovery machine will stop automatically.
(press the power button, the machine will be forced start and it stops again after 20 seconds)
8. This unit can be used together with a float level sensor. Please connect the recovery unit and the tank with the 80% O.F.P. Cable. If the liquid refrigerant reaches 80% capacity of the tank the recovery unit will automatically shut off and the O.F.P. Light turns on.

Before restart please change a new tank.

OPERATION MANUAL

9. If the refrigerant tank doesn't have float level sensor, please take the 80% O.F.P Cable off. Otherwise the recovery unit can not started. In this case, an electric scale is required to monitor the recovered refrigerant amount.
10. In order to gain maximum recover speed, a hose with inner diameter larger than 4mm is recommended and the hose should better be shorter than 1.5m.
11. While recovering large amounts of liquid, use the Push/Pull Mode.
12. After recovering, make sure there is no refrigerant left in the unit. Read the Purge Operation carefully. Remained liquid refrigerant in the unit may be expanded and damage the components.
13. If the unit is to be stored or not used for any length of time, we recommend that it be completely evacuated of any residual refrigerant and purged with dry nitrogen.
14. Connection hose with check valve is recommended, it can prevent refrigerant lose.
15. The Low Pressure Gauge shows the pressure of the intake port of the compressor and the High Pressure Gauge shows the pressure of the outlet port of the recovery unit.
16. Press the the “▼” button will scroll through each common unit, select the required unit.
(when the intake is negative pressure, the unit of air pressure will automatically switch to inHg)
17. Please press the “⏻” button to shut down the machine.
18. After using, please make ture the knob to “Close” position.

SPECIFICATION

| VRR24M | |
|-------------------------|--|
| Refrigerants | Category III: R12, R134a, R401C, R406A, R500, 1234YF Category IV: R22, R401A, R401B, R402B, R407C, R407D, R408A, R409A, R411A, R411B, R412A, R502, R509 Category V: R402A, R404A, R407A, R407B, R410A, R507, R32 |
| Power | 100V, 50/60Hz; 110V~120V, 50/60Hz; 220V~240V, 50/60Hz |
| Motor | Brushless Motor, 1 HP |
| Motor Speed | 3000 RPM |
| Maximal Current Draw | 100V: 11A; 110V: 10.5A; 220V: 5A |
| Compressor | Oil-less, Air-cooled, Piston |
| High Pressure Protector | 38.5bar/3850kPa(558psi) |
| Operating Temperature | 0°C~40°C/32~104°F |
| Dimensions | 380×250×260 (mm) |
| Net Weight | 10.5 kg |

VRR24M

| Refrigerants | R134a | R22 | R410A |
|--------------|------------|------------|------------|
| Liquid | 2.40kg/min | 2.70kg/min | 3.50kg/min |
| Push/Pull | 7.50kg/min | 8.50kg/min | 9.50kg/min |

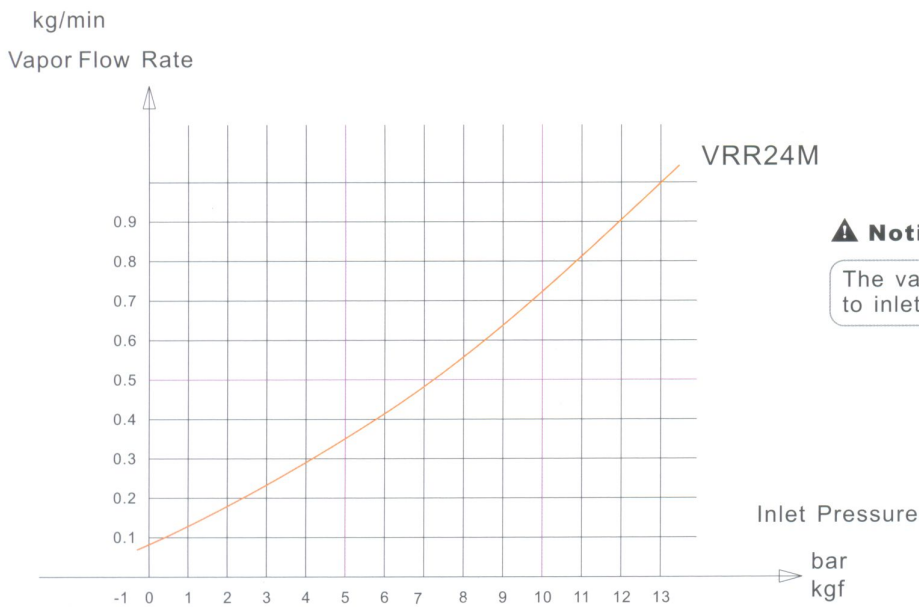

Notice

The vapor flow rate is proportioned to inlet pressure.

INTRODUCTION OF OPERATION PANEL

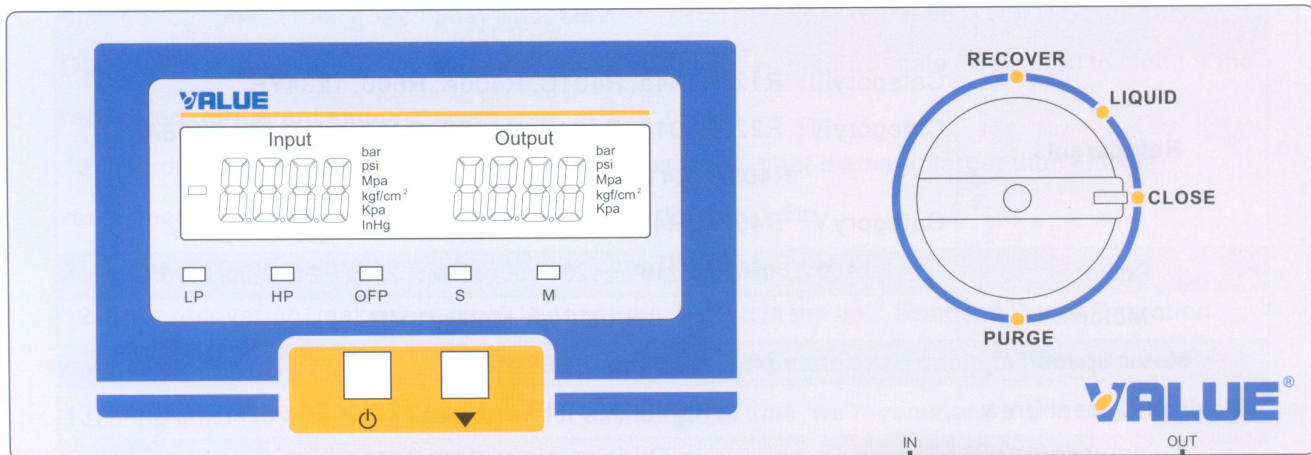

⏻: Power switch

▼: Function switch

LP: The inlet low pressure indication, when the pressure dropped to -15 inHg after 20s light is on, while returned to atmospheric pressure light blinks

HP: The outlet high pressure indication, when the pressure is over 38.6 bar the light is on for long time, while below 29 bar light blinks

OFP: When refrigerant reaches 80% of the tank, O.F.P. light works

O.F.P. light light blinks once refrigerant is less than 80%

S: Flashing security instructions, when the pressure over 42 bar the light is on for long time, while below 36 bar light blinks

M: brushless motor fault indication

⚠ Notice

1. When each LED light is blinking or LP light is on, press the power button to restart the machine.
2. The machine will stop when alarm light is on. The machine can be restarted when each light blinks which means corresponding function of each light has worked and already recovered.
3. Sometimes brushless motor failure (M) needs power off the unit.
4. Press function button for 10 s (function light is on) to zero set and then release function button to finish zero set
 - a. When the reading of the LCD exceeds 1 bar, zero set is not available;
 - b. Zero set is needed on condition of pressure reading is not at zero when inlet and outlet is open under normal temperature.
5. If the digital screen appears "E1", that shows the sensor is not connected well while the machine can operate normally, but can not read the pressure. Please stop the machine and check for safety purpose.

PARTS DIAGRAM

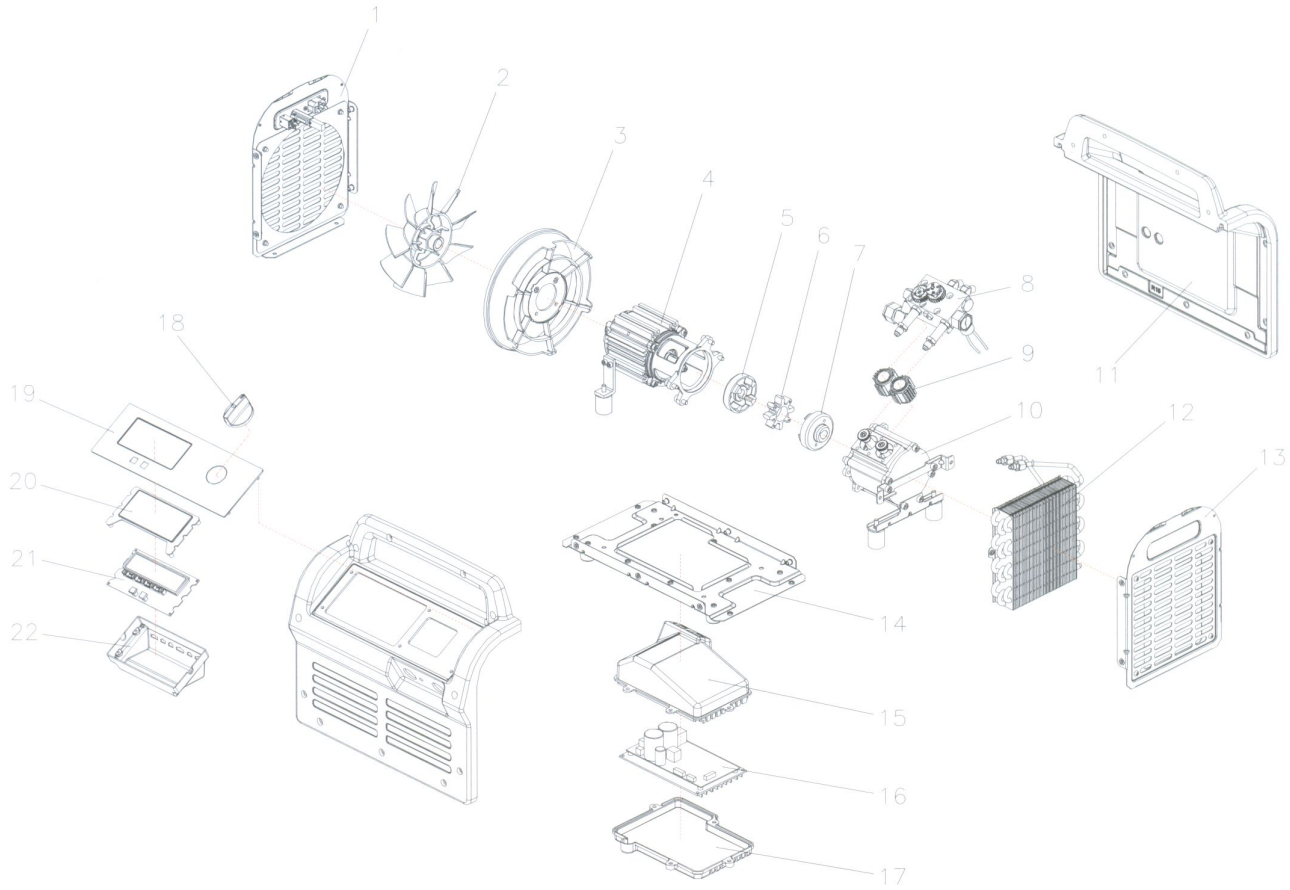

| NO. | ITEM | NO. | ITEM |
|-----|---------------------|-----|---------------------------|
| 1 | Side cover(fan) | 12 | Condenser |
| 2 | Fan | 13 | Side cover(condenser) |
| 3 | Fan cover | 14 | Base plate |
| 4 | Motor assembly | 15 | Motor circuit board cover |
| 5 | Coupling | 16 | Motor control board |
| 6 | Elastic coupling | 17 | Motor circuit board base |
| 7 | Coupling | 18 | Knob |
| 8 | Control valve | 19 | Front plate |
| 9 | Cylinder | 20 | LCD cover |
| 10 | Compressor assembly | 21 | LCD circuit board |
| 11 | Back cover | 22 | LCD base |

WIRING DIAGRAM

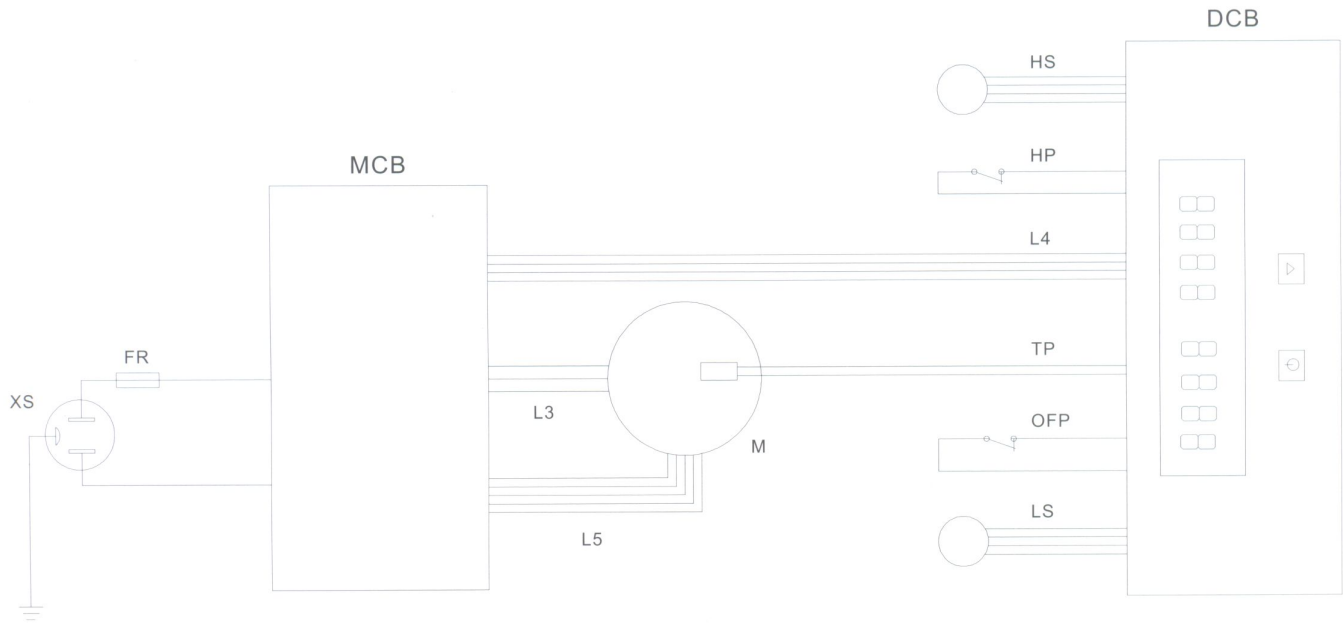

| NO. | Graphics Code | ITEM | NO. | Graphics Code | ITEM |
|-----|---------------|-----------------------------|-----|---------------|----------------------|
| 1 | DCB | Digital gauge control board | 6 | HS | High pressure sensor |
| 2 | LS | Low pressure sensor | 7 | M | Motor |
| 3 | OFP | Over filling protector | 8 | MCB | Motor control board |
| 4 | TP | Temperature protector | 9 | FR | Overload protector |
| 5 | HP | High pressure switch | 10 | XS | Socket |

OPERATING INSTRUCTION

1). Refrigerant pipes' exhaust

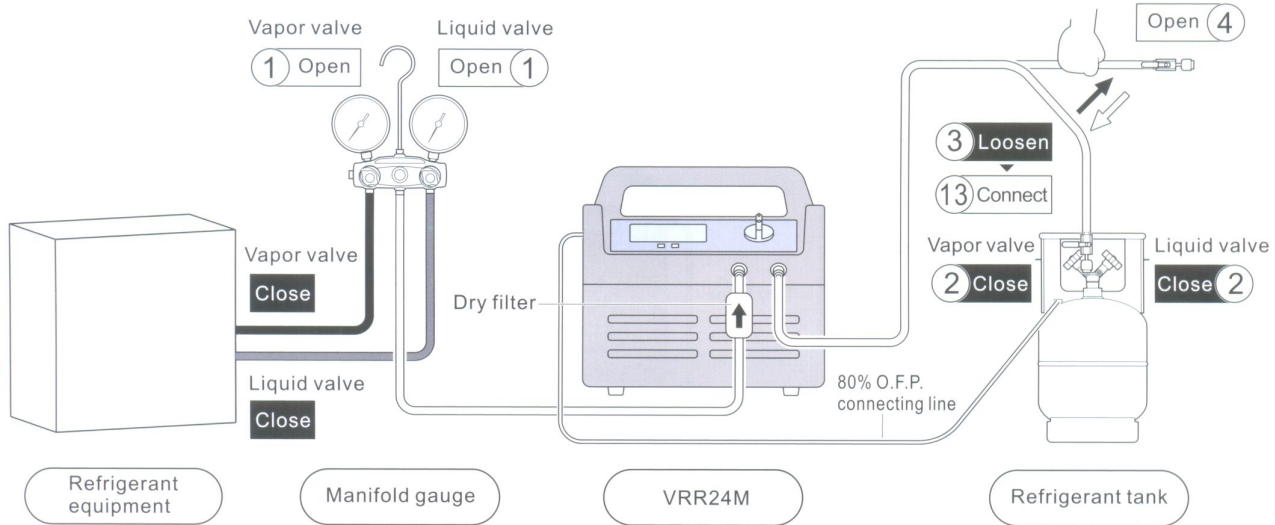

Ready for operation

※Connect the pipes correctly and firmly.

(Please refer to the connection diagram)

1. Open the vapor and liquid valves of manifold gauge.
2. Close the vapor and liquid valves of tank.
3. Loosen the connecting pipes of refrigerant tank.
4. Open the check valve of pipes.

Start operation

5. Plug in the machine and the LCD shows inlet pressure.
6. Turn the knob to "Recover".
7. Press the "⏻" button to start machine, it begins to purge inner air of the hose.
8. Observe the reading of the low pressure gauge when it reaches to -15inHg, after 20 seconds, LP light works and the machine stops work .

9. Turn the knob to "Close", LP light blinks, press the power button and start machine.

10. Turn the knob slowly to "Purge" and start self purging.
11. Observe the reading of the low pressure gauge when it reaches to -15inHg for the second time, after 20 seconds, LP light works and the machine stops work .

Finish operation

12. Turn the knob to "Close" and stop self purging.
13. Connect the refrigerant hose to the tank.

OPERATING INSTRUCTION

2). Recovery mode

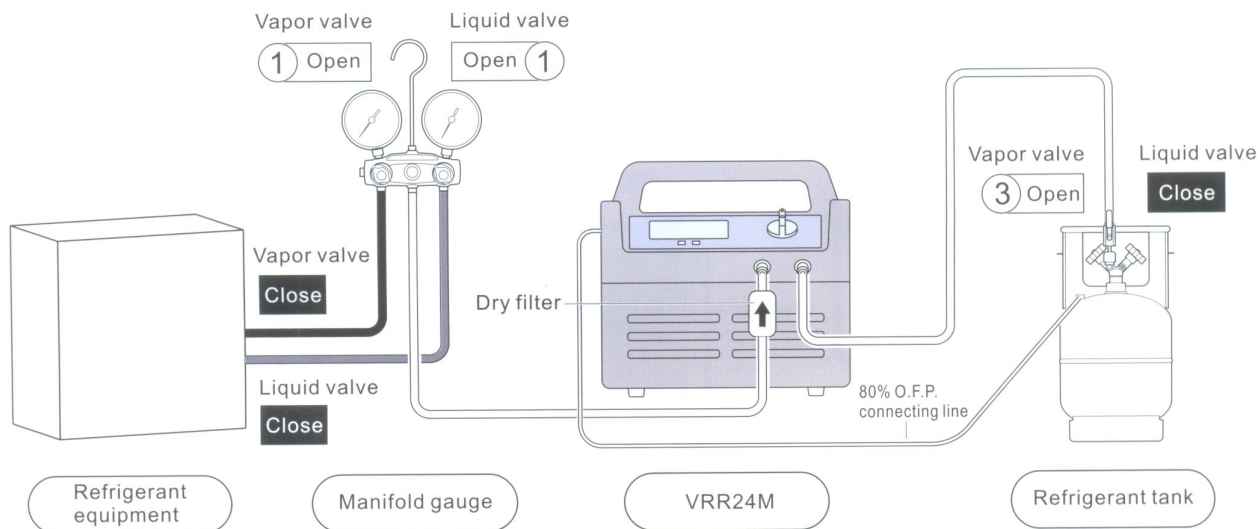

Ready for operation

※Connect the pipes correctly and firmly.

(Please refer to the connection diagram)

※Make sure all valves are closed.

1. Switch off the power of refrigerant equipment.
2. Open the vapor and liquid valves of refrigerant equipment.
3. Open the vapor valve of the refrigerant tank.

Start operation

4. Turn the knob to "Recover".
5. Press the " ⏻ " button to start machine.
6. a. If recover liquid refrigerant, please open the liquid valve of the manifold gauge.
b. If recover vapor refrigerant, please open the vapor valve of the manifold gauge.

7. The recovery mode will be finished when machine runs to certain vacuum degree or automatic close of low pressure protection..

※Do not turn off the power after recovery finished and directly run self purging mode.

⚠ Notice

- ① If fluid hammer happens in the recovery, please turn the knob to "Liquid" position slowly, Then the reading of low pressure gauge drops until fluid hammer stops; but do not let reading pressure drop to zero, otherwise inlet port is not pumping once at zero pressure.
- ② If restart after power-off or start with difficulty, please turn knob to "Close" and press " ⏻ " button and start the machine, then turn the knob to "Recover".

OPERATING INSTRUCTION

3). Self-purge mode

▲ Notice

The unit must be purged after each use;
Liquid refrigerant remained may expand and damage the components and pollute the environment.

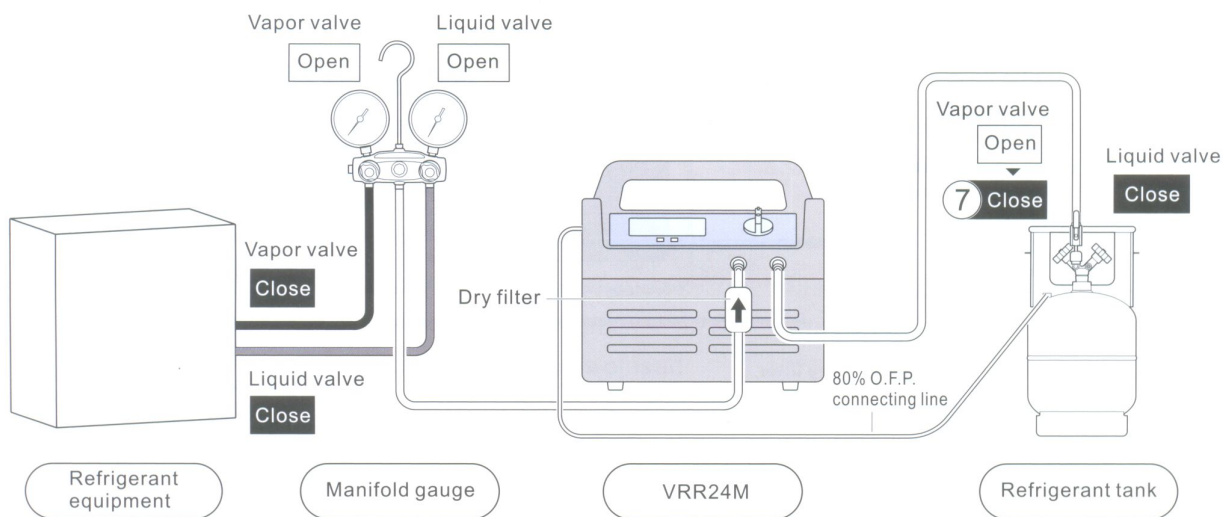

Start operation

1. The machine stops automatically after recovery finished with LP light on.
2. Turn the knob to "Close" and the LP light blinks, press "⏻" button to start the machine.
3. Turn the knob to "Purge" and start self purging.
4. The self purging mode will be finished when machine runs to certain vacuum degree.

Finish operation

5. Turn the knob to "Close".
6. Close the check valve which connected to exhaust.
7. Close the vapor valve of the tank.

OPERATING INSTRUCTION

4). Liquid push/pull mode

⚠ Notice

An electric scale is needed to monitor the recover process to prevent overfilling.

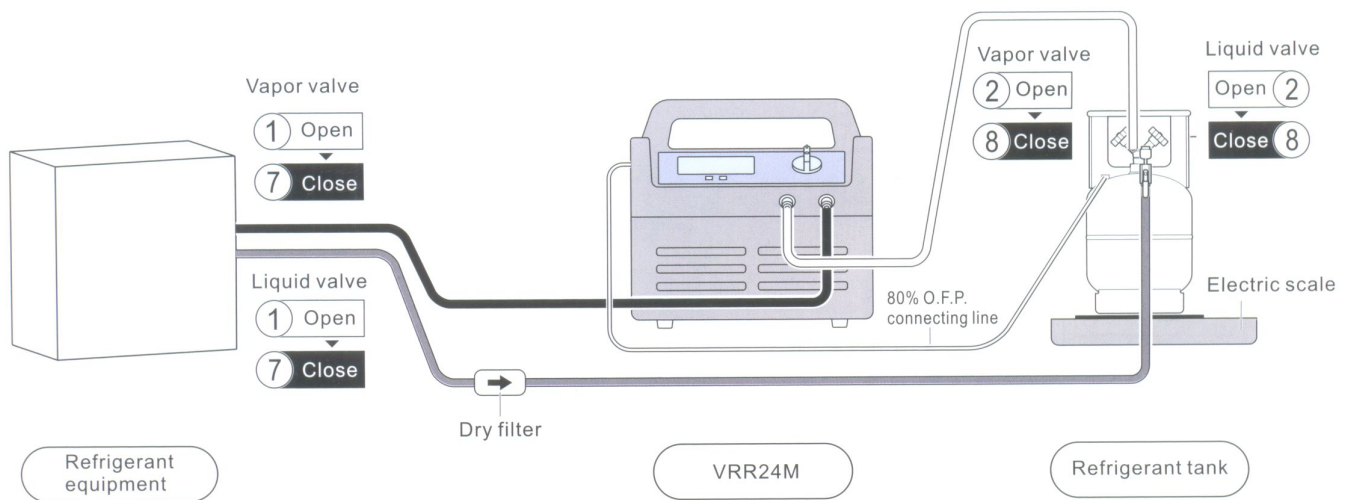

Ready for operation

- ※Connect the pipes correctly and firmly.
(Please refer to the connection diagram)
- ※Make sure all valves are closed.

Start operation

1. Open the vapor valve, liquid valve of the HVAC system.
 2. Open the vapor valve, liquid valve of the tank.
 3. Turn the knob to "Recover".
 4. Press " ⏸ button to start machine, then it starts liquid push/pull mode.
- ※ If the reading on the scale keeps the same or changes slowly, it means liquid in HVAC system has been recovered and vapor recovery mode can be underway.

5. Turn the knob slowly to "Purge" and start self purging mode for the liquid.
6. Turn the knob to "Close".
7. Close the vapor valve, liquid valve of the HVAC system.
8. Close the vapor valve, liquid valve of the tank.
9. Reconnect the hoses and start recovery mode for the vapor.

Finish operation

TROUBLE SHOOTING

| PROBLEM | CAUSE | SOLUTION |
|---|--|--|
| LCD does not work after power on | <ol style="list-style-type: none"> 1.Inner connecting lines get loose 2.Malfunction of LCD circuit board | <ol style="list-style-type: none"> 1.Check the connecting lines 2.Change the LCD circuit board or contact local VALUE distributor |
| The recovery unit does not work after pressing power button | <p>Power button light is off</p> <ol style="list-style-type: none"> 1.One of the LP,HP,OFP,S,M light is on 2.Malfunction of circuit board <p>Power button light is on</p> <ol style="list-style-type: none"> 1.External pressure is too high 2.Damage of motor or other parts | <ol style="list-style-type: none"> 1.Check the connecting lines 2.Change the circuit board or contact local VALUE distributor 1.Turn the knob to CLOSE and restart 2.Contact local VALUE distributor |
| The recovery unit stops after running a period of time | <ol style="list-style-type: none"> 1.HP switch is disconnected due to misoperation, HP light blinks, such as output valve, tank valve is closed 2.Disconnect of thermal protector in motor and M light is on 3.The percent of refrigerant in the tank reaches 80% and OFP light is on 4.LP light is on due to recovery process is finished 5.Overload protector is disconnected | <ol style="list-style-type: none"> 1.Please read the manual carefully and strictly execute to the manual and follow the instructions while operating 2.Wait for a moment and the compressor will restart automatically 3.Change to empty tank and restart 4.Start the self purging mode 5.Reset overload protector after 5 minutes' cooling |
| Slow recover speed | <ol style="list-style-type: none"> 1.The pressure of the refrigerant tank is too high 2.Damage of piston ring in compressor | <ol style="list-style-type: none"> 1.Cool the tank down can help bringing down the pressure 2.Contact local VALUE distributor |
| Unit doesn't pull out a vacuum | <ol style="list-style-type: none"> 1. Connecting hoses get loose 2. Recovery machine leaks | <ol style="list-style-type: none"> 1.Tighten connecting hoses 2.Contact local VALUE distributor |

VALUE[®]